

Bid Tab for RFB 493557 1.5 TON UTILITY TRUCK

				Bob Maxey Ford, Inc. 1833 E Jefferson Ave Detroit, MI 48207			Feldman Ford, LLC 8333 Michigan Ave Detroit, MI 48210		
Vehicle	Year	Qty	U/M	PRICE	TOTAL PRICE	PRICE	TOTAL PRICE		
1 ½ Ton Utility Trucks on Heavy Duty Chassis Cab (Four Wheel Drive) with Roller Top Truck Bed with 185 CFM Underdeck PTO Drive Air Compressor	2022	2	EA	\$ 138,594.00	\$277,188.00	\$ 161,429.00	\$322,858.00		
				\$ 138,594.00	\$277,188.00	\$ 161,429.00	\$322,858.00		
Guaranteed Buy-Back				Years	%	Value	Years	%	Value
				2	21.6%	\$ 30,000.00	2	5%	\$ 8,071.00
				4	10.8%	\$ 15,000.00	4	3%	\$ 4,842.00
				5	7.2%	\$ 10,000.00	5	2%	\$ 3,228.00
				7	3.6%	\$ 5,000.00	7	1%	\$ 1,614.00
Warranty				Years	Mileage	Cost (included in Vehicle cost)	Years	Mileage	Cost
Standard Warranty	3	YR	3	36,000	\$ -	5	36,000	\$ -	
Extended Warranty	5	100,000	5	100,000	\$ 1,985.00	5	100,000	\$ 3,230.00	
Powertrain	5	100,000	5	60,000	\$ -				
Engine	5	100,000	5	100,000	\$ -				
Upfitter Vendor				Santoro, Inc. 15232 Harper Ave Detroit, MI 48224			Santoro, Inc. 15232 Harper Ave Detroit, MI 48224		
Is the upfitter an authorized OEM distributor and installer				Yes			Yes		
Authorization Letter submitted with bid				Yes			Yes		
Within 40-mile radius of 6425 Huber (CSF)				Yes			Yes		
Total Bid:				\$277,188.00			\$326,088.00		
DBB % & Credit				0%			0%		
DRB % & Credit				\$0.00			\$0.00		
Equalized Total Bid				\$277,188.00			\$326,088.00		
				Clearances Expire: 10/6/22 Specification Deviations: No Print for Underdeck air compressor provided: Yes, Upfitter verification letter provided: Yes # of years providing this type of equipment: 18			Clearances Expire: 10/13/22 Specification Deviations: No Print for Underdeck air compressor provided: Yes, see attached Upfitter verification letter provided: Yes, see attached # of years providing this type of equipment:		
				Lowest Responsible and Responsive Bidder					

BOB MAXEY UPFITTER'S INFORMATION

11 Pages including this one



**AUTOMOTIVE SERVICES
& EQUIPMENT SALES**

Quotation
April 13, 2022

To: Bob Maxey Ford
1833 E. Jefferson Ave.
Detroit, MI 48207

Attn: Mr. Bob Maxey
Mr. Joe Theis

Ultimate Customer: Detroit Water RFB493557

- Qty
- (2) 2" Pintle/ball hitch with safety eyes.
- (2) Cole-Hersee #1235 6-pin socket and 7-way Bargeman with wiring mounted near pintle hitch.
- (2) 10LB ABC fire extinguisher mounted in cab.
- (2) Electronic back-up alarms.
- (2) Model PW1500-12 power inverter.
- (2) Monroe Custom Model TM4-108M5320 service body with lighting and accessories per pages 7 thru 10, items "A" thru "Y", and items # 1 thru 5 inclusive.
- (2) Boss Model 8060-UBI B-Car PTO drive underdeck air compressor system in strict accordance with pages 11 thru 13, items 1 thru 10.

Net price installed in strict accordance with Detroit RFB493557 specifications# 1-1/2
THUHDC4DCCWEPHCRTTBWUDAC-MT4X4-15-03
F.O.B: 15232 Harper, Detroit, MI 48224 @ vehicle

***Important Note:** Chassis Dealer must order vehicles with standard 40 gallon "AFT-OF-AXLE FUEL TANK ONLY, 60" CA Chassis and Ford Code 62R PTO provision. Chassis dealer must provide a "DEF" relocation kit with each chassis and "drop ship" kit along with chassis to MCB, Inc. Greenfield, IN 46140. Must include body prints and dealer letters with bid submission.

Option A) Deduct for crane reinforced body (see attached drawing #108/57-RT-Santoro/4)
\$ 2,108.00 per vehicle Total \$ 4,216.00

Terms: Net 10 days
Delivery: Pending on Chassis ETA
Price Firm: 45 Days - subject to MFG price increases
F.O.B: Detroit

Paul Vitale
Authorized Signature

P.O. BO 24228 • 15232 HARPER • DETROIT, MI 48224
BUS: (313) 526-1300 • FAX: (313) 526-6240

A 15232 Harper Ave, Detroit, MI 48224

12 mi, 8.4 miles

B 6425 Huber St, Detroit, MI 48211

Light traffic (Leave at 9:46 AM)
Via I-94 W, M-53

SANTORO, INC
 15232 Harper
 Detroit, MI 48224
 (313) 526-1300

A 15232 Harper Ave, Detroit, MI 48224

↑	1. Head west on Harper Ave toward Lakepointe St	0.4 mi
↶	2. Turn left onto Chalmers St Captain Jay's Fish & Chicken on the corner	289 ft
⦿	3. Take the ramp on the right and follow signs for I-94 West	2.9 mi
↑	4. At Exit 218, head right on the ramp for M-53 toward Van Dyke Ave	0.2 mi
↷	5. Turn right onto M-53 / Van Dyke St	1.0 mi
↶	6. Turn left onto Grinnell St Sunoco on the corner	0.3 mi
↑	7. Road name changes to Winfield	364 ft
↷	8. Turn right • Private Road	341 ft
↷	9. Turn right • Private Road	0.3 mi
↶	10. Take a sharp left	0.1 mi
11.	Arrive at destination	

B 6425 Huber St, Detroit, MI 48211

These directions are subject to the Microsoft® Service Agreement and are for informational purposes only. No guarantee is made regarding their completeness or accuracy. Construction projects, traffic, or other events may cause actual conditions to differ from these results. Map and traffic data © 2022 TomTom.

**Santoro, Inc.
15232 Harper
Detroit, MI 48224**

4/8/22

To Whom It May Concern:

Please accept this letter that Santoro, Inc. is an authorized distributor for Monroe Custom Bodies, Inc. (MCB) in the Detroit, MI territory. This includes the entire product line for sales and service.

Should there be any questions or concerns regarding this letter please direct them to me.

**Regards,
Larry Patterson**

**Larry A. Patterson
Sales Dir.**

**MCB Service Bodies and Accessories
2155 Fields Blvd, Greenfield, IN 46140
larry2@monroebodies.com**



Morroe Custom Utility Bodies, Inc.
www.morroeutilitybodies.com

Customer: Santoro, Inc.
Ref. Project: Detroit Water - WITH CRANE

Order / Quote No. 46851

Date 03/23/22

Sheet 1 of 1

Drawing No. 108/57-TM4-Santoro/5

Curbside View

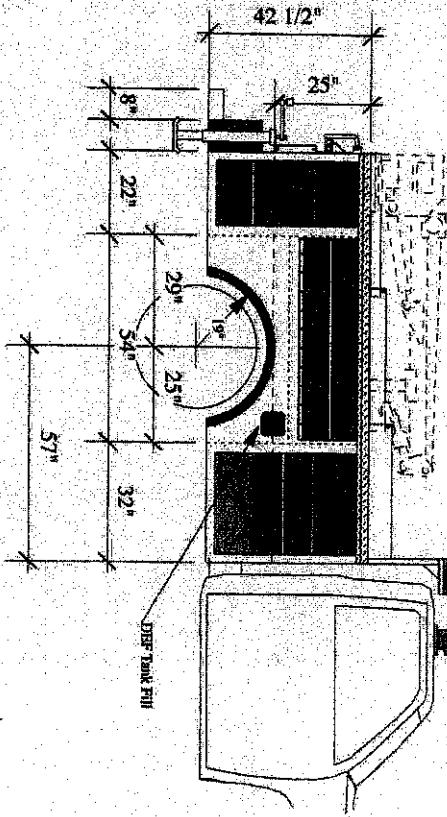

Streetside View

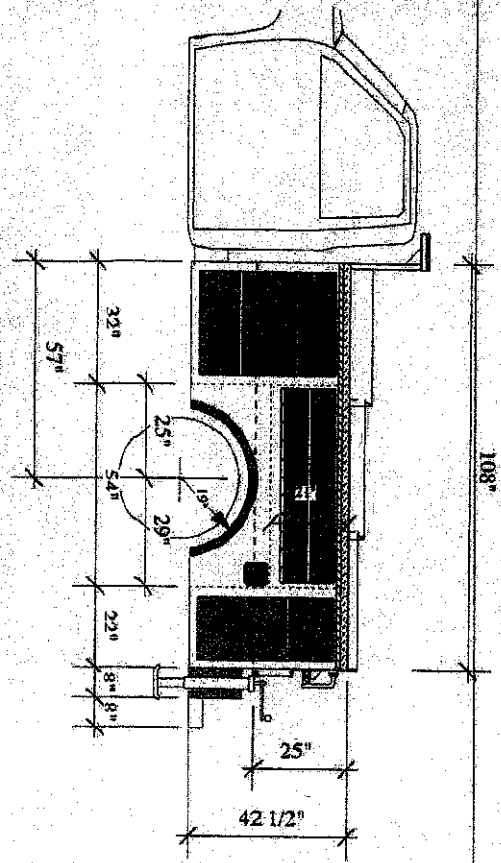

Go Light
Radio Ray

Rear View

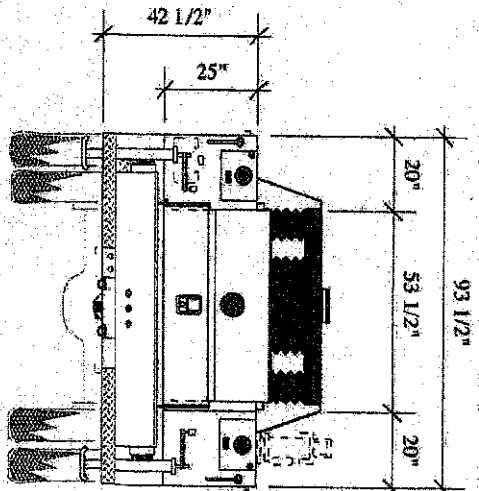

NOTE:
* This project drawing and any other documentation further describing the product shown on this drawing are the sole property of Morroe Custom Utility Bodies, Inc. based in Grandfield, IN (M/C/B).
* Any reproduction, transmission, or distribution in part or in whole, without the intended recipient, and/or their employees, is prohibited, unless otherwise allowed in writing by M/C/B or M/C/B's authorized representative.



Morose Custom Utility Bodies, Inc.

www.morosebodies.com

Customer: Santoro Inc.

Ref. Project: Detroit Water - NO CRANE

Order / Quote No.

46851

Date

03/23/22

Sheet

1 of 1

Drawing #

108/57/RL-SANTORO/4

Curbside View

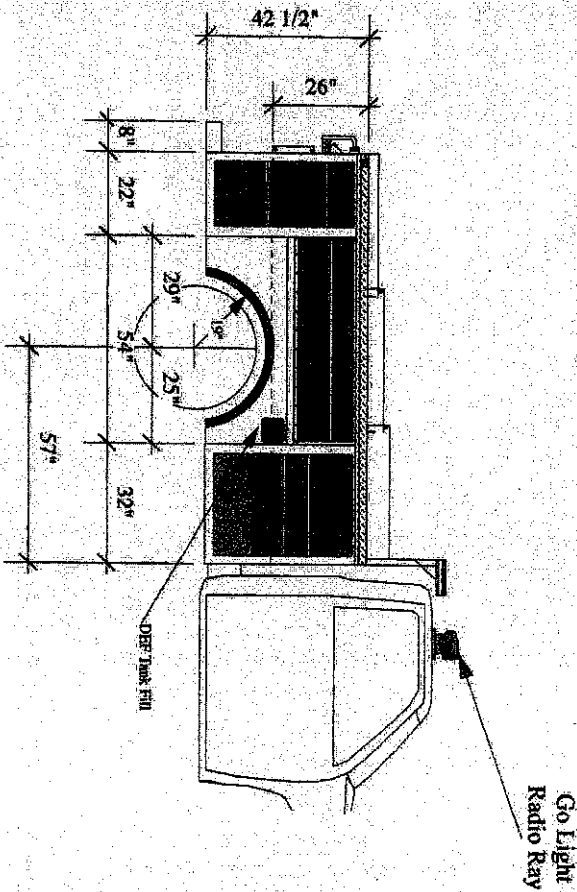

Streetside View

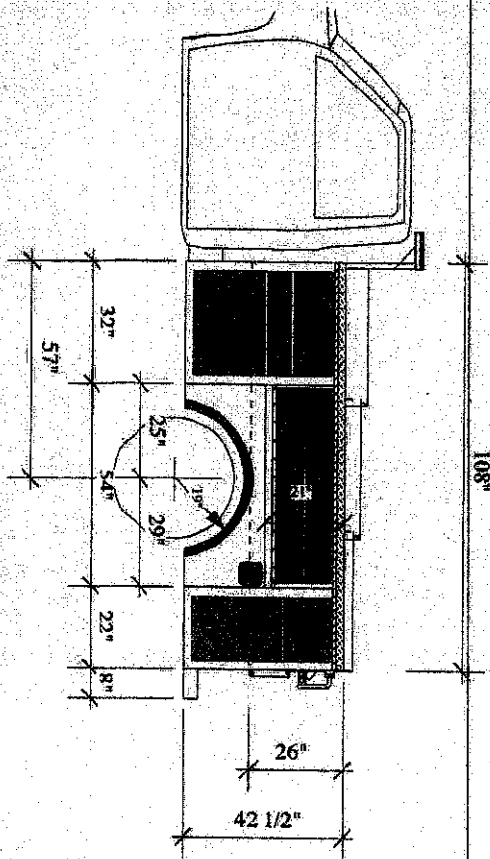

Rear View

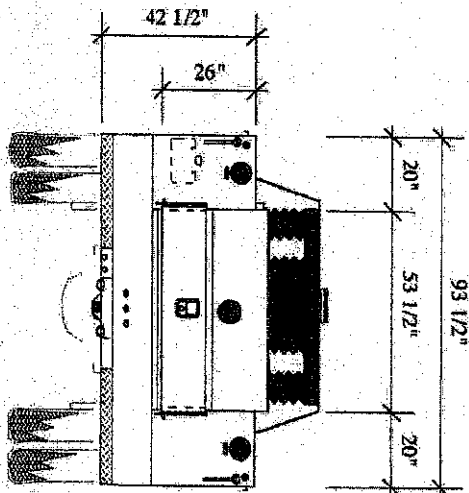

as per "A"

NOTE:
 * This project drawing and any other documentation further describing the products shown on this drawing are the sole property of Morose Custom Utility Bodies, Inc. located in Gosport, IN (M/C/B).
 * Any reproduction, translation, or distribution to parties other than the intended recipient, and/or their employees, is prohibited, unless otherwise allowed in writing by M/C/B or M/C/B's authorized representative.



April 7, 2022

SANTORO, INC
Attn: Mr. Dave Santoro- President
15232 Harper Avenue
Detroit MI 48224

Dear Mr. Santoro,

I am writing in regards to our dealer arrangement. Santoro, Inc. is an authorized installation and service center for the complete Boss product line for Metro Detroit accounts.

Santoro, Inc has put forth the time, energy and resources to best understand our products through continuing education for both sales and service of our products to best serve the end-user.

If you have any further questions, please do not hesitate to contact me at 219.363.3488.

Best regards,

A handwritten signature in black ink, appearing to read "Todd Hudson".

Todd Hudson
President

1761 Genesis Drive La Porte, IN 46350 | www.bossair.com | (800) 635-6587





**ROTARY
SCREW**

8060 / 80100 UBI PTO Drive Underdeck Rotary Screw Air Compressor

When you utilize a BOSS® UBI PTO
air compressor on your crew trucks...

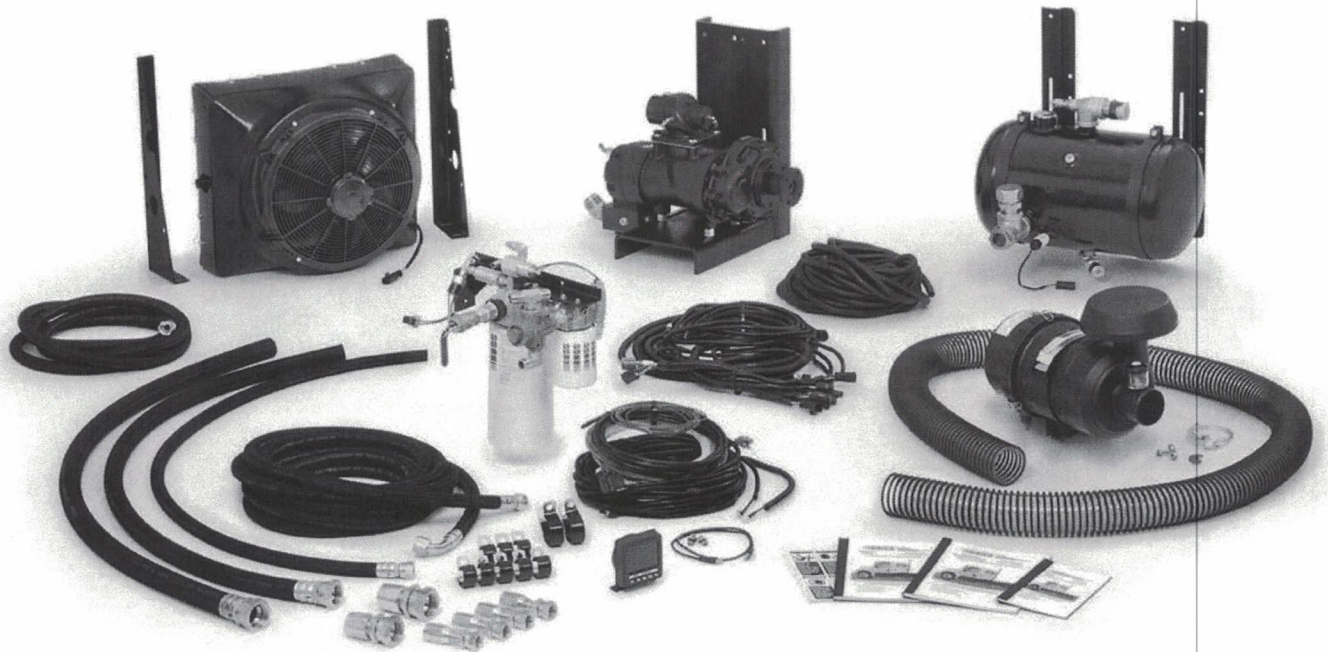

...you gain a decisive edge!

more air solutions at
BOSSair.com
BOB MAXEY

BOSS®
engineered **AIR** systems

8060 / 80100 UBI PTO Drive

Underdeck Rotary Screw Air Compressor

The **BOSS® UBI PTO** design allows you the option to choose any cfm output up to 85cfm utilizing the **80100** or up to 185cfm with the **8060**. By simply adjusting the engine speed control, the compressor will produce the cfm continuously. Once the **UBI PTO** is engaged, engine torque and horsepower are transmitted to the air compressor via a properly sized tubular drive shaft. The speed control for the compressor modulates according to air demand, which offers fuel savings, as well as, reduces wear and tear on the vehicle's engine. When the job is complete, simply disengage the **UBI PTO** and continue to the next job site.

Because the **UBI PTO** air compressor components become an integral part of the vehicle and are mounted below the body, it offers many advantages you cannot get when using conventional air compressors.

- **Frees up the tow hitch**
- **Takes up no body space**
- **Fewer parts** - Compared to its towable or cross-mount counterparts
- **Light weight** - Less than 285lbs for the **80100** and 425lbs for the **8060**
- **Only one engine to maintain** - Simplifies preventive maintenance
- **Cost savings** - No need for additional licensing fees or insurance

The B-CAN Compressor Control System



DURABLE. CAPABLE. RELIABLE.

The **B-CAN** is a remote compressor control system featuring a 3.5 inch fully sunlight viewable screen that is menu based for service and diagnostic information.

- USB interface allows quick and easy software updates
- Internal buzzer to alert operators of warnings and shutdowns
- Plug-and-go solution for displaying J1939 engine and transmission data
- Service interval alarms
- Robust polycarbonate case with IP67 rating
- Fully-sealed *Deutsch®* electrical connectors

SPECIFICATIONS

COMPRESSOR	MODEL 80100 UBI PTO*			
Delivery @ 100psig**	30cfm	45cfm	60cfm	85cfm
Input speed to compressor shaft (rpm)	960	1395	1815	2500
Fluid capacity (gallons)	2.2	2.2	2.2	2.2

Note: input speeds may vary depending on chassis application.
*Hydraulic drive option available. Consult factory.
**125psig and 150psig available. Consult factory.

COMPRESSOR	MODEL 8060 UBI PTO*			
Delivery @ 110psig**	100cfm	125cfm	160cfm	185cfm
Input speed to compressor shaft (rpm)	1200	1450	1875	2160
Fluid capacity (gallons)	4.75	4.75	4.75	4.75

Note: input speeds may vary depending on chassis application.
*Hydraulic drive option available. Consult factory.
**125psig and 150psig available. Consult factory.

COMPONENTS	80100	8060
Compressor air-end	10" W x 16" H x 18" L	10" W x 8" H x 15" L
Receiver sump	12" dia x 22" L	12" dia x 22" L
Spin-on coalescer	5 1/2" dia x 12" H	5 1/2" dia x 12" H
12vdc remote cooler assembly***	27" W x 16 3/4" H x 19 1/4" L	27" W x 16 3/4" H x 19 1/4" L
Gauge package	3 3/4" W x 4 1/4" H x 3" L	3 3/4" W x 4 1/4" H x 3" L
Weight (dry)	285lbs.	425lbs.

***24vdc is available.

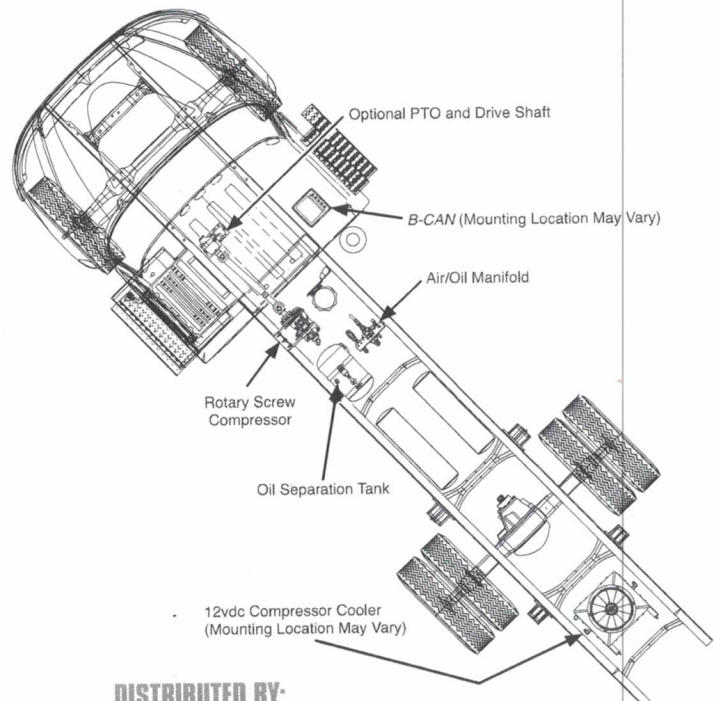

DISTRIBUTED BY:

SANTORO, INC

15232 Harper
Detroit, MI 48224
(313) 526-1300



BOSS INDUSTRIES, INC.

1761 Genesis Drive LaPorte, IN 46350
Voice: (219) 324-7776 • (800) 635-6587 • Fax: (219) 324-7470
Electronic: www.bossair.com • email: sales@bossair.com

Specifications subject to change without notice. ©2014 Boss Industries, Inc. Printed In U.S.A. 8060/80100 UBI PTO. 250. 022614. IF 9



WARRANTY STATEMENT

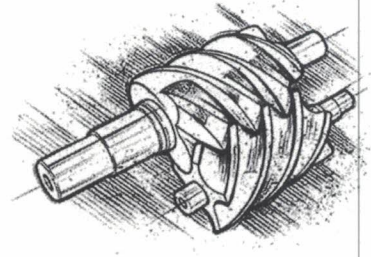

This limited warranty provided by Boss Industries, LLC (“BOSS”) is subject to the expressed terms and conditions described herein. BOSS warrants to the machine’s original buyer (“BUYER”) that this compressor unit conforms to applicable drawings and specifications approved in writing by BOSS. The machine will be free from defects in material and workmanship for the period of time listed in the chart below while the machine is owned by BUYER.

Component	Warranty Period
Rotary Screw Airend with Continuation of ShieldWorks Maintenance Plan	Lifetime*
Rotary Screw Airend	30 Months
Piston Pump	18 Months
PTO Factory Installation	12 Months
All Other Parts	Manufacturer’s Warranty

*Every BOSS rotary screw airend comes with BOSS ShieldWorks, and the BUYER initiates the lifetime warranty program with completion of the lifetime warranty registration card. To continue the lifetime warranty coverage, this product must be registered and maintained according to the proper schedule. After purchase, BOSS ShieldWorks lubricant and oil filter must be replaced after initial fifty (50) hours of use. Then, at one (1) year or five hundred (500) hours, whichever comes first, a complete service must be performed to maintain the warranty status, along with providing maintenance records to BOSS. After the initial year, the maintenance schedule should be followed per your provided manual, with record retention.

This warranty covers net cost of the part only. Labor, mileage, and travel time, including diagnostic calls to analyze the problem, are not covered by this or any other warranty. In the event of a warranty claim by an end-user, an authorized BOSS distributor shall be responsible for the initial investigation and warranty claim. The remedy of repair or replacement parts shall be carried out by BOSS or an authorized distributor.

*BOSS INDUSTRIES, LLC
1761 GENESIS DRIVE
LA PORTE, IN 46350
(800) 635-6587*

This warranty is not transferable. The total responsibility of BOSS for claims, losses, liabilities, or damages, whether in contract or tort, related to its products shall not exceed the purchase price. In no event shall BOSS be liable for any special, indirect, incidental, or consequential damages including, but not limited to, loss of use of facilities or equipment, loss of profits, property damage, or lost production, whether suffered by BUYER or any third party. Warranty will be void if product is altered without written approval by BOSS. BOSS shall have no responsibility for any cost or expense incurred by BUYER if damage results from accident, misuse, neglect, improper installation, or the use of replacement parts or fluids not of BOSS manufacture. Wear caused by chemicals, abrasions, or excessive heat is not considered a defect and is not covered by this warranty. Maintenance and wear items such as lubricants, belts, seals, and filters are not warrantable items.

BUYER must provide written notice of each occurrence of an alleged defect in material or workmanship. If the machine is within the specified warranty period and has been registered and maintained according to the proper schedule, BOSS will provide return shipping instructions. Upon return of the item FOB BOSS original shipping point, BOSS will repair or replace the item or issue credit for replacement, provided it is found to be defective. Defective material must be returned within thirty (30) days of receiving return instructions from BOSS. Failure to do so within specified time will result in forfeiture of claim.

Failure to follow procedures as laid out in this warranty statement may cause forfeiture of claim. Excess freight charges from failure to follow shipping instructions will be deducted from credit. Distributors or end-users automatically deducting the value of a warranty claim from outstanding balances due prior to receiving written notification of BOSS approval of the warranty claim may be subject to forfeiture of the entire claim.

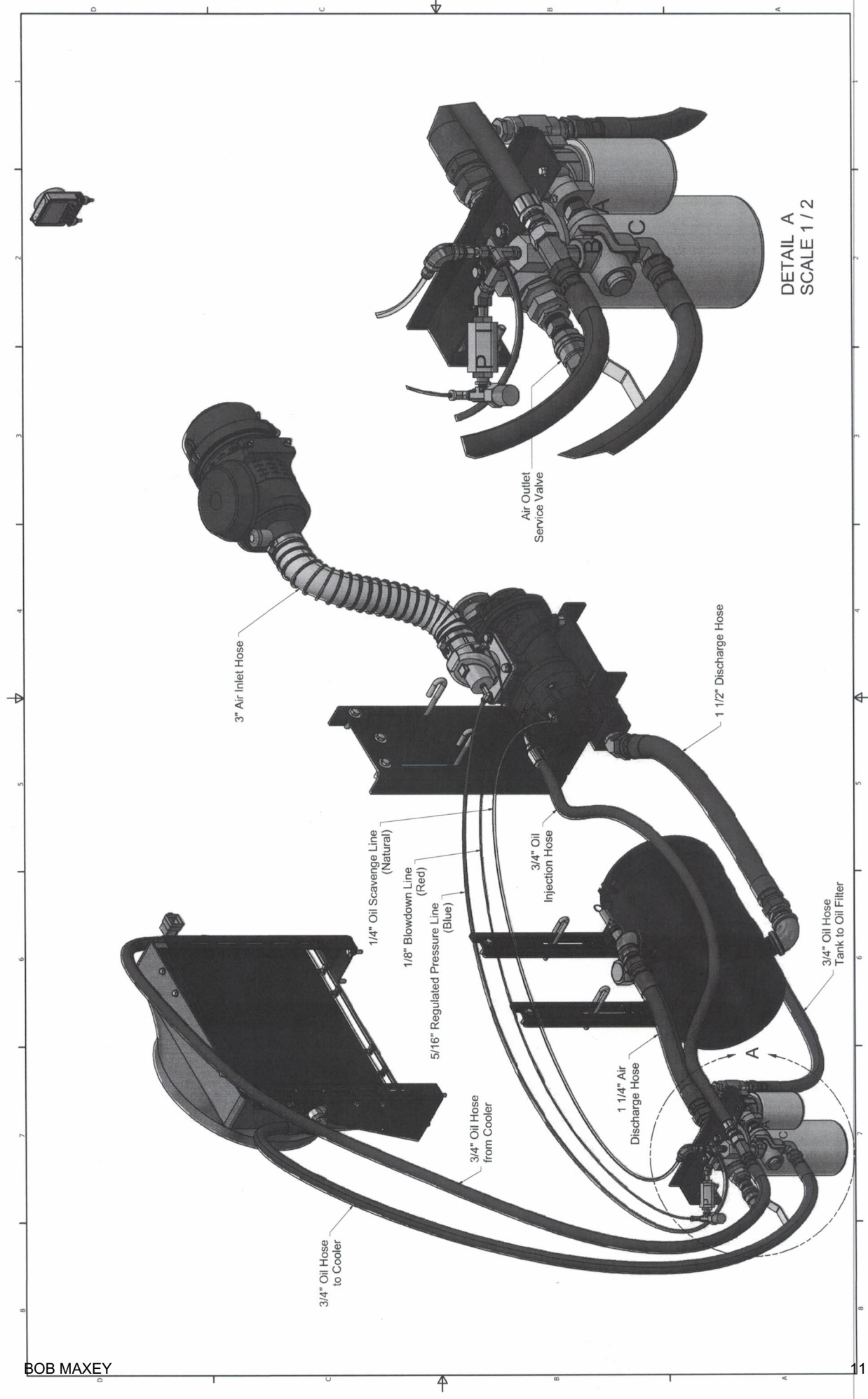

DETAIL A
SCALE 1/2

3" Air Inlet Hose

Air Outlet Service Valve

1 1/2" Discharge Hose

1/4" Oil Scavenge Line (Natural)

1/8" Blowdown Line (Red)

5/16" Regulated Pressure Line (Blue)

3/4" Oil Injection Hose

3/4" Oil Hose Tank to Oil Filter

3/4" Oil Hose from Cooler

1 1/4" Air Discharge Hose

3/4" Oil Hose to Cooler

FELDMAN FORD
10 Pages including this one



**AUTOMOTIVE SERVICES
& EQUIPMENT SALES**

Quotation
April 13, 2022

To: Feldman Ford of Detroit
8333 Michigan Ave.
Detroit, MI 48210

Attn: Mr. Bill McCarthy

Ultimate Customer: Detroit Water RFB493557

Qty

- (2) 2" Pintle/ball hitch with safety eyes.
- (2) Cole-Hersee #1235 6-pin socket and 7-way Bargeman with wiring mounted near pintle hitch.
- (2) 10LB ABC fire extinguisher mounted in cab.
- (2) Electronic back-up alarms.
- (2) Model PW1500-12 power inverter.
- (2) Monroe Custom Model TM4-108M5320 service body with lighting and accessories per pages 7 thru 10, items "A" thru "Y", and items # 1 thru 5 inclusive.
- (2) Boss Model 8060-UBI B-Can PTO drive underdeck air compressor system in strict accordance with pages 11 thru 13, items 1 thru 19.

Net price installed in strict accordance with Detroit RFB493557 specifications# 1-1/2
THUHDC4DCCWEPHCRTTBWUDAC-MT4X4-15-03
F.O.B: 15232 Harper, Detroit, MI 48224 @

***Important Note:** Chassis Dealer must order vehicles with standard 40 gallon "AFT-OF-AXLE FUEL TANK ONLY, 60" CA Chassis and Ford Code 62R PTO provision. Chassis dealer must provide a "DEF" relocation kit with each chassis and "drop ship" kit along with chassis to MCB, Inc. Greenfield, IN 46140. Must include body prints and dealer letters with bid submission.

Terms: Net 10 days
Delivery: Pending on Chassis ETA
Price Firm: 45 Days – subject to MFG price increases
F.O.B: Detroit

Paul Vitale
Authorized Signature

A 15232 Harper Ave, Detroit, MI 48224

B 6425 Huber St, Detroit, MI 48211









12 min, 5.4 miles

Light traffic (Leave at 9:46 AM)
Via I-94 W, M-53

SANTORO, INC

15232 Harper
Detroit, MI 48224
(313) 526-1300

A 15232 Harper Ave, Detroit, MI 48224

	1. Head west on Harper Ave toward Lakepointe St	0.4 mi
	2. Turn left onto Chalmers St Captain Jay's Fish & Chicken on the corner	289 ft
	3. Take the ramp on the right and follow signs for I-94 West	2.9 mi
	4. At Exit 218 , head right on the ramp for M-53 toward Van Dyke Ave	0.2 mi
	5. Turn right onto M-53 / Van Dyke St	1.0 mi
	6. Turn left onto Grinnell St Sunoco on the corner	0.3 mi
	7. Road name changes to Winfield	364 ft
	8. Turn right <small>• Private Road</small>	341 ft
	9. Turn right <small>• Private Road</small>	0.3 mi
	10. Take a sharp left	0.1 mi
	11. Arrive at destination	

B 6425 Huber St, Detroit, MI 48211

These directions are subject to the Microsoft® Service Agreement and are for informational purposes only. No guarantee is made regarding their completeness or accuracy. Construction projects, traffic, or other events may cause actual conditions to differ from these results. Map and traffic data © 2022 TomTom

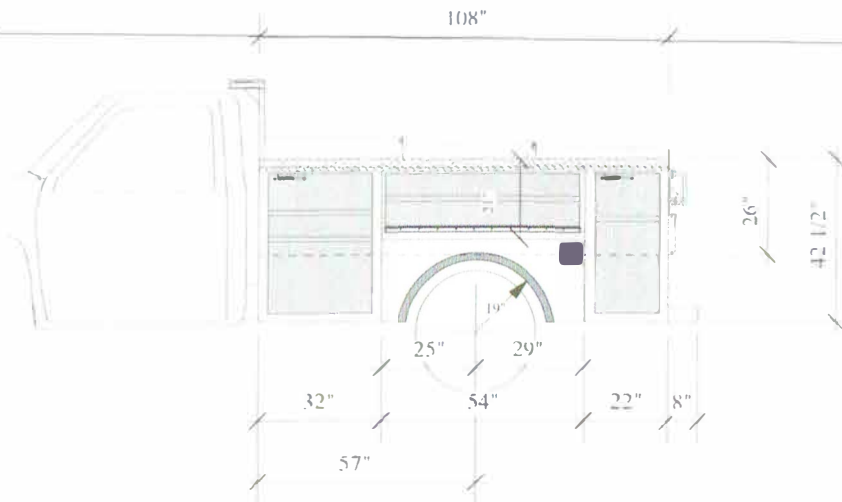

Streetside View

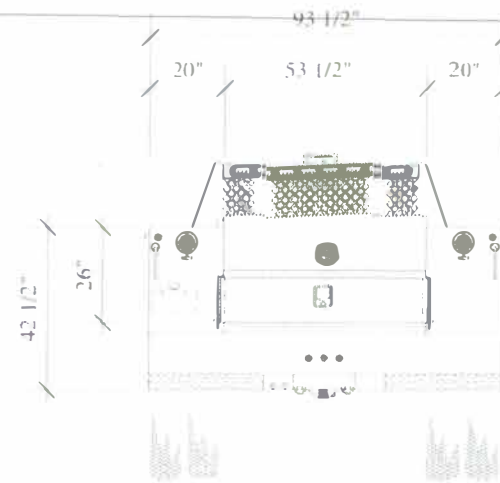

Rear View

Go Light
Radio Ray

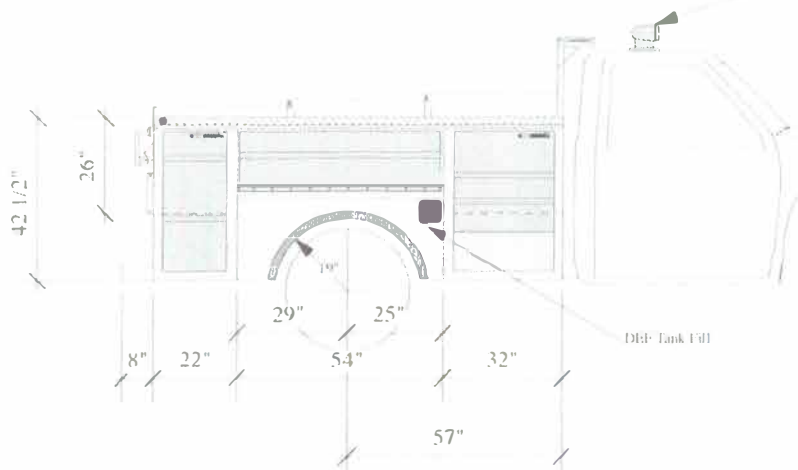

Curbside View

OPTION "A"

NOI
 * This project drawing and any other documentation further describing the products shown on this drawing are the sole property of Monroe Custom Utility Bodies, Inc. located in Greenfield, IN (MCB).
 * Any reproduction, transmittal, or distribution to parties other than the intended recipients, and/or their employees, is prohibited, unless otherwise allowed in writing by MCB or MCB's authorized representative.



April 7, 2022

SANTORO, INC

Attn: Mr. Dave Santoro- President
15232 Harper Avenue
Detroit MI 48224

Dear Mr. Santoro,

I am writing in regards to our dealer arrangement. Santoro, Inc. is an authorized installation and service center for the complete Boss product line for Metro Detroit accounts.

Santoro, Inc has put forth the time, energy and resources to best understand our products through continuing education for both sales and service of our products to best serve the end-user.

If you have any further questions, please do not hesitate to contact me at 219.363.3488.

Best regards,

A handwritten signature in black ink, appearing to read "Todd Hudson".

Todd Hudson
President

1761 Genesis Drive La Porte, IN 46350 | www.bossair.com | (800) 635-6587





**ROTARY
SCREW**

8060 / 80100 UBI PTO Drive Underdeck Rotary Screw Air Compressor

When you utilize a BOSS® UBI PTO
air compressor on your crew trucks...

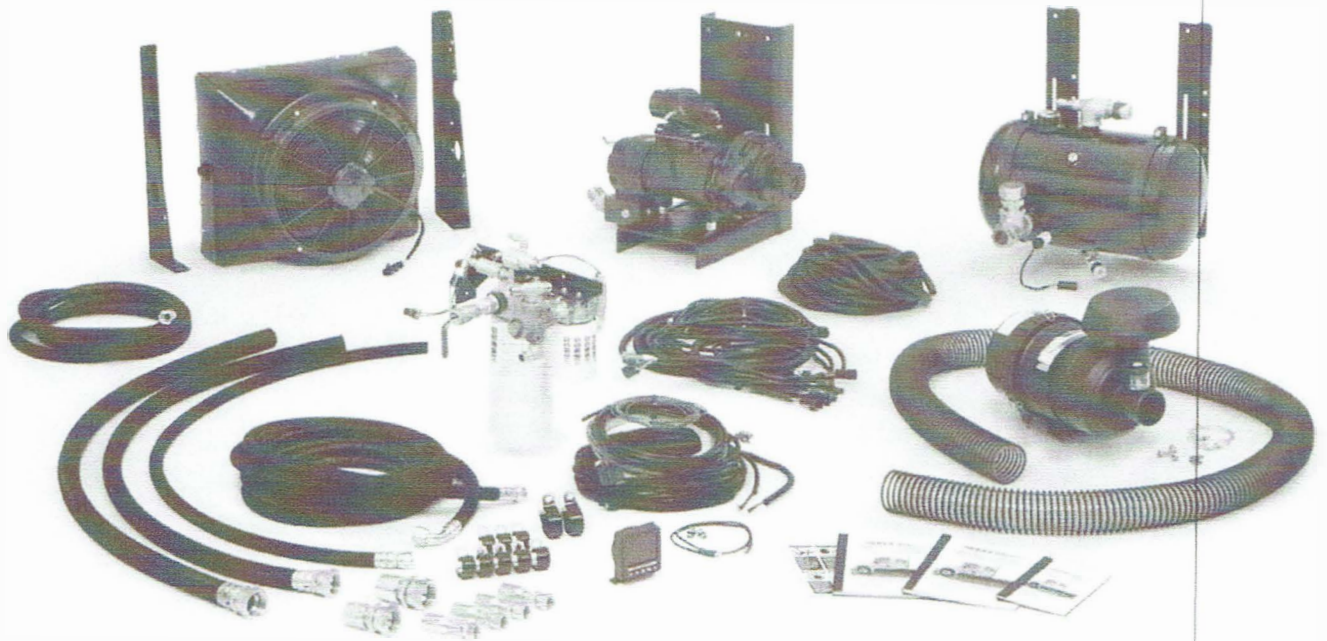

...you gain a decisive edge!

more air solutions at
BOSSair.com

FELDMAN FORD

BOSS®
engineered AIR systems

8060 / 80100 UBI PTO Drive

Underdeck Rotary Screw Air Compressor

The **BOSS® UBI PTO** design allows you the option to choose any cfm output up to 85cfm utilizing the **80100** or up to 185cfm with the **8060**. By simply adjusting the engine speed control, the compressor will produce the cfm continuously. Once the **UBI PTO** is engaged, engine torque and horsepower are transmitted to the air compressor via a properly sized tubular drive shaft. The speed control for the compressor modulates according to air demand, which offers fuel savings, as well as, reduces wear and tear on the vehicle's engine. When the job is complete, simply disengage the **UBI PTO** and continue to the next job site.

Because the **UBI PTO** air compressor components become an integral part of the vehicle and are mounted below the body, it offers many advantages you cannot get when using conventional air compressors.

- **Frees up the tow hitch**
- **Takes up no body space**
- **Fewer parts** - Compared to its towable or cross-mount counterparts
- **Light weight** - Less than 285lbs for the **80100** and 425lbs for the **8060**
- **Only one engine to maintain** - Simplifies preventive maintenance
- **Cost savings** - No need for additional licensing fees or insurance

SPECIFICATIONS

COMPRESSOR	MODEL 80100 UBI PTO*			
Delivery @ 100psig**	30cfm	45cfm	60cfm	85cfm
Input speed to compressor shaft (rpm)	960	1395	1815	2500
Fluid capacity (gallons)	2.2	2.2	2.2	2.2

Note: input speeds may vary depending on chassis application.
 *Hydraulic drive option available. Consult factory.
 **125psig and 150psig available. Consult factory.

COMPRESSOR	MODEL 8060 UBI PTO*			
Delivery @ 110psig**	100cfm	125cfm	160cfm	185cfm
Input speed to compressor shaft (rpm)	1200	1450	1875	2160
Fluid capacity (gallons)	4.75	4.75	4.75	4.75

Note: input speeds may vary depending on chassis application.
 *Hydraulic drive option available. Consult factory.
 **125psig and 150psig available. Consult factory.

COMPONENTS	80100	8060
Compressor air-end	10" W x 16" H x 18" L	10" W x 8" H x 15" L
Receiver sump	12" dia x 22" L	12" dia x 22" L
Spin-on coalescer	5 1/2" dia x 12" H	5 1/2" dia x 12" H
12vdc remote cooler assembly***	27" W x 16 3/4" H x 19 1/4" L	27" W x 16 3/4" H x 19 1/4" L
Gauge package	3 3/4" W x 4 1/8" H x 3" L	3 3/4" W x 4 1/8" H x 3" L
Weight (dry)	285lbs.	425lbs.

***24vdc is available.

The B-CAN Compressor Control System



DURABLE. CAPABLE. RELIABLE.

The **B-CAN** is a remote compressor control system featuring a 3.5 inch fully sunlight viewable screen that is menu based for service and diagnostic information.

- USB interface allows quick and easy software updates
- Internal buzzer to alert operators of warnings and shutdowns
- Plug-and-go solution for displaying J1939 engine and transmission data
- Service interval alarms
- Robust polycarbonate case with IP67 rating
- Fully-sealed *Deutsch®* electrical connectors

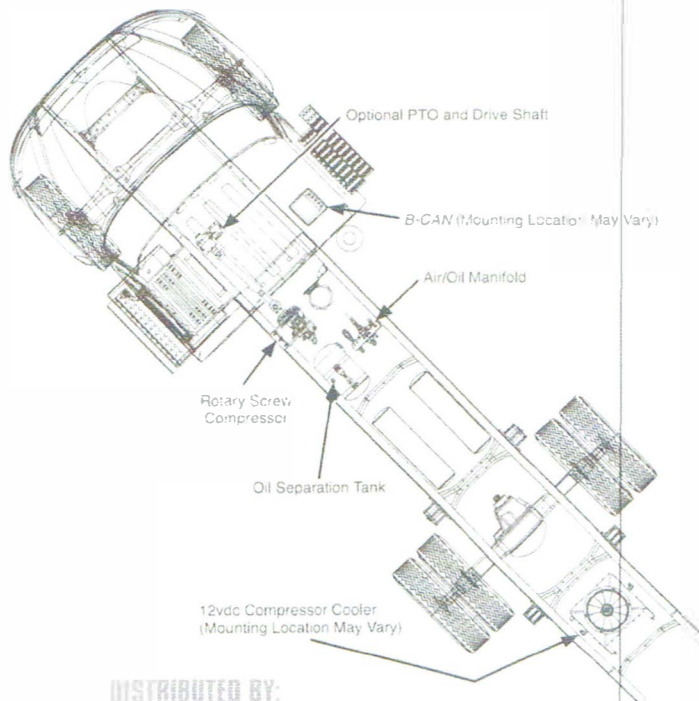

DISTRIBUTED BY:

SANTORO, INC

15232 Harper
 Detroit, MI 48224
 (313) 526-1300



BOSS INDUSTRIES, INC.

1761 Genesis Drive LaPorte, IN 46350
 Voice: (219) 324-7776 · (800) 635-6587 · Fax: (219) 324-7470
 Electronic: www.bossair.com · email: sales@bossair.com

Specifications subject to change without notice.
 ©2014 Boss Industries, Inc. Printed in U.S.A. 8060/80100 UBI PTO, 250, 022614, IF



WARRANTY STATEMENT

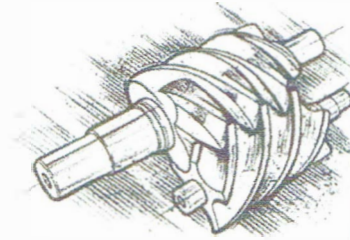

This limited warranty provided by Boss Industries, LLC ("BOSS") is subject to the expressed terms and conditions described herein. BOSS warrants to the machine's original buyer ("BUYER") that this compressor unit conforms to applicable drawings and specifications approved in writing by BOSS. The machine will be free from defects in material and workmanship for the period of time listed in the chart below while the machine is owned by BUYER.

Component	Warranty Period
Rotary Screw Airend with Continuation of ShieldWorks Maintenance Plan	Lifetime*
Rotary Screw Airend	30 Months
Piston Pump	18 Months
PTO Factory Installation	12 Months
All Other Parts	Manufacturer's Warranty

*Every BOSS rotary screw airend comes with BOSS ShieldWorks, and the BUYER initiates the lifetime warranty program with completion of the lifetime warranty registration card. To continue the lifetime warranty coverage, this product must be registered and maintained according to the proper schedule. After purchase, BOSS ShieldWorks lubricant and oil filter must be replaced after initial fifty (50) hours of use. Then, at one (1) year or five hundred (500) hours, whichever comes first, a complete service must be performed to maintain the warranty status, along with providing maintenance records to BOSS. After the initial year, the maintenance schedule should be followed per your provided manual, with record retention.

This warranty covers net cost of the part only. Labor, mileage, and travel time, including diagnostic calls to analyze the problem, are not covered by this or any other warranty. In the event of a warranty claim by an end-user, an authorized BOSS distributor shall be responsible for the initial investigation and warranty claim. The remedy of repair or replacement parts shall be carried out by BOSS or an authorized distributor.

*BOSS INDUSTRIES, LLC
1761 GENESIS DRIVE
LA PORTE, IN 46350
(800) 635-6587*

This warranty is not transferable. The total responsibility of BOSS for claims, losses, liabilities, or damages, whether in contract or tort, related to its products shall not exceed the purchase price. In no event shall BOSS be liable for any special, indirect, incidental, or consequential damages including, but not limited to, loss of use of facilities or equipment, loss of profits, property damage, or lost production, whether suffered by BUYER or any third party. Warranty will be void if product is altered without written approval by BOSS. BOSS shall have no responsibility for any cost or expense incurred by BUYER if damage results from accident, misuse, neglect, improper installation, or the use of replacement parts or fluids not of BOSS manufacture. Wear caused by chemicals, abrasions, or excessive heat is not considered a defect and is not covered by this warranty. Maintenance and wear items such as lubricants, belts, seals, and filters are not warrantable items.

BUYER must provide written notice of each occurrence of an alleged defect in material or workmanship. If the machine is within the specified warranty period and has been registered and maintained according to the proper schedule, BOSS will provide return shipping instructions. Upon return of the item FOB BOSS original shipping point, BOSS will repair or replace the item or issue credit for replacement, provided it is found to be defective. Defective material must be returned within thirty (30) days of receiving return instructions from BOSS. Failure to do so within specified time will result in forfeiture of claim.

Failure to follow procedures as laid out in this warranty statement may cause forfeiture of claim. Excess freight charges from failure to follow shipping instructions will be deducted from credit. Distributors or end-users automatically deducting the value of a warranty claim from outstanding balances due prior to receiving written notification of BOSS approval of the warranty claim may be subject to forfeiture of the entire claim.

